

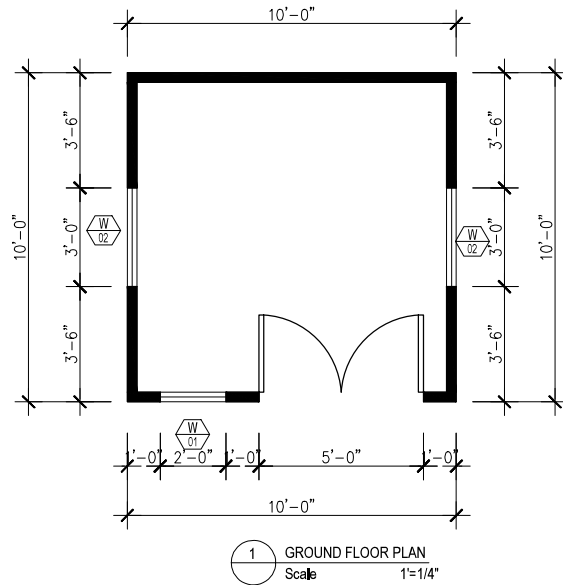

THE VEGAS 0BD 0BA 100 SQ.FT.





1 GROUND FLOOR PLAN
Scale 1"=1/4"

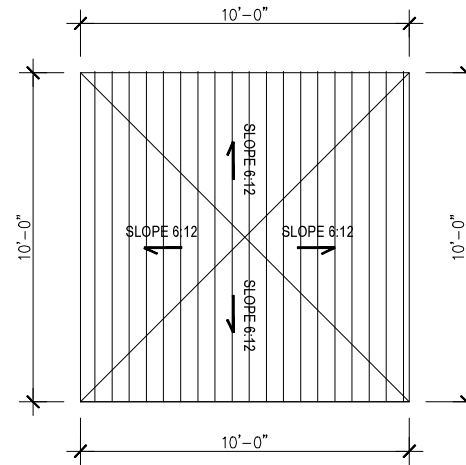

1 GROUND FLOOR PLAN
Scale 1"=1/4"

AREA SCHEDULE

The Vegas	100 SF
-----------	--------

SCHEDULE OF DOORS

DOOR MK	STRUCT. OPNG.		DOOR ROU. OPNG.		NOS. REQD.
	W	HT	W	HT	
D1	80"	80"	63,75"	80,75"	01

SCHEDULE OF WINDOWS

DOOR MK	STRUCT. OPNG.		WINDOW ROU. OPNG.		NOS. REQD.
	W	HT	W	HT	
W1	24"	72"	24,5"	42,5"	01
W2	36"	48"	36,5"	48,5"	02

GROUND & ROOF FLOOR PLAN

DESIGN: The Vegas	ADDRESS	S.P.	ISSUE:	REV	DATE	DESCRIPTION	DRAWN	CHECKED	
STAGED PLAN PRELIMINARY		SCALE @ A3	DWG NO. AR-001	LAND AREA:					
CLIENT:	USE FIGURED DIMENSIONS AT ALL TIMES. REFER ANY ENQUIRIES TO BUILDING CONTRACTOR. ALL DIMENSIONS TO BE VERIFIED ON SITE PRIOR TO CONSTRUCTION. ALL WORK TO COMPLY WITH LOCAL AUTHORITY REGULATIONS.								

PRELIM - NOT FOR CONSTRUCTION



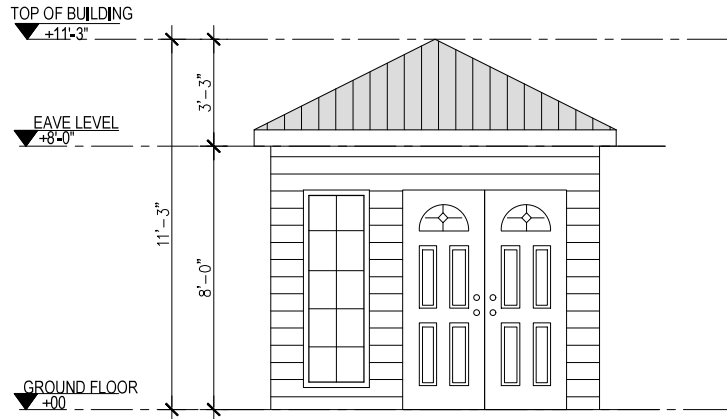

1 FRONT ELEVATION
Scale 1"=1/4"

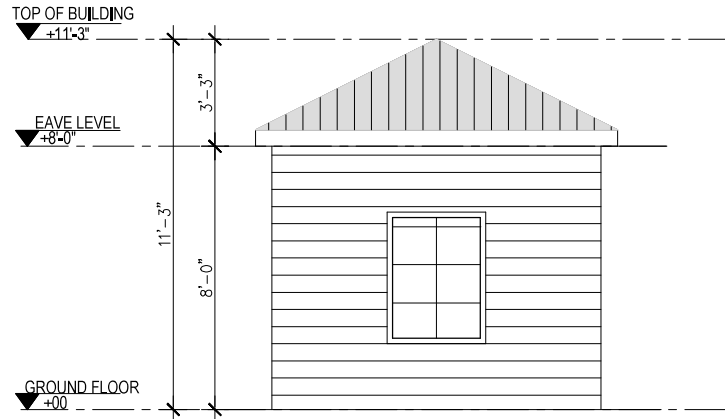

3 RIGHT SIDE ELEVATION
Scale 1"=1/4"

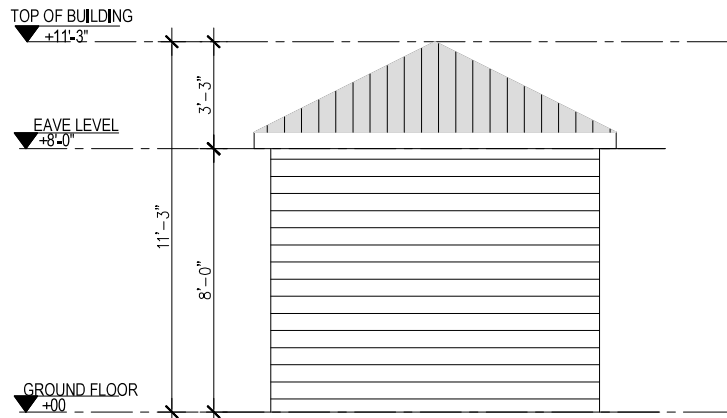

2 REAR ELEVATION
Scale 1"=1/4"

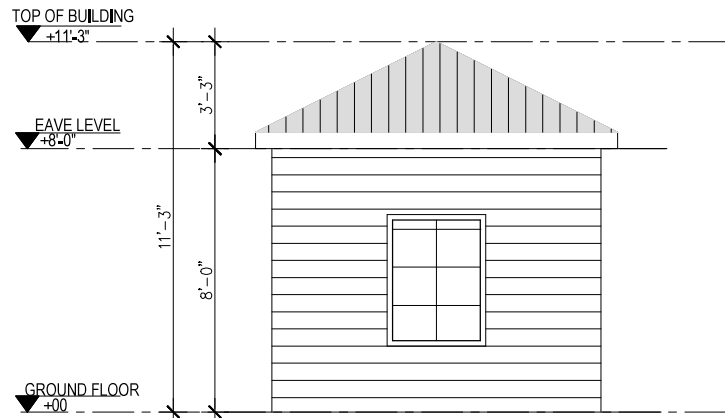

4 LEFT SIDE ELEVATION
Scale 1"=1/4"

ELEVATIONS

DESIGN: The Vegas	ADDRESS	S.P.	ISSUE:	REV	DATE	DESCRIPTION	DRAWN	CHECKED
STAGED PLAN PRELIMINARY		SCALE @ A3						
CLIENT:	USE FIGURED DIMENSIONS AT ALL TIMES. REFER ANY ENQUIRIES TO BUILDING CONTRACTOR. ALL DIMENSIONS TO BE VERIFIED ON SITE PRIOR TO CONSTRUCTION. ALL WORK TO COMPLY WITH LOCAL AUTHORITY REGULATIONS.	DWG NO: AR-002	LAND AREA:					

PRELIM - NOT FOR CONSTRUCTION



What will you do with your Small Space?

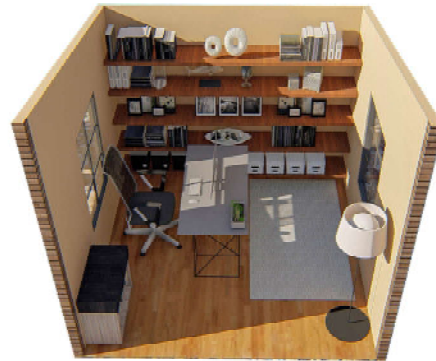

Please refer to the floor plans for recommendations on your interior layout.

Drawings are not to scale. Colors and materials indicative only and are subject to change

Options available

- For any modifications to the plans, please contact us at info@welldone1kithomes.com

Website : www.welldone1kithomes.com

Email : info@welldone1kithomes.com

DESIGN:

The Vegas

STAGED PLAN::

PRELIMINARY

ADDRESS:

US

USE FIGURED DIMENSIONS AT ALL TIMES. REFER ANY ENQUIRES TO BUILDING CONTRACTOR. ALL DIMENSIONS TO BE VERIFIED ON SITE PRIOR TO CONSTRUCTION. ALL WORK TO COMPLY WITH LOCAL AUTHORITY REGULATIONS.

PRELIMINARY DESIGN-
Not for construction

